

— SENSOR DATA
— WIFI
— LAN
— 12V
— POWER FROM BATTERY

ON  LAN RESET 



aranet

Quick Start Guide

Aranet PRO

1. Check the contents of the box

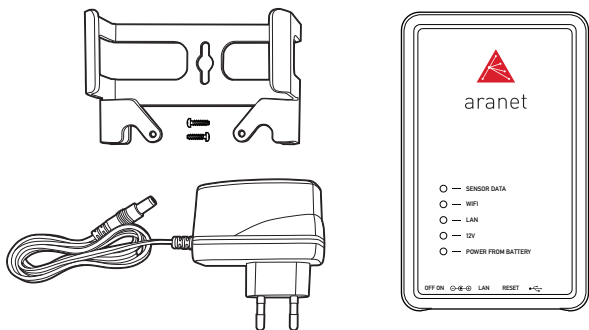

2. Attach the device to the mount

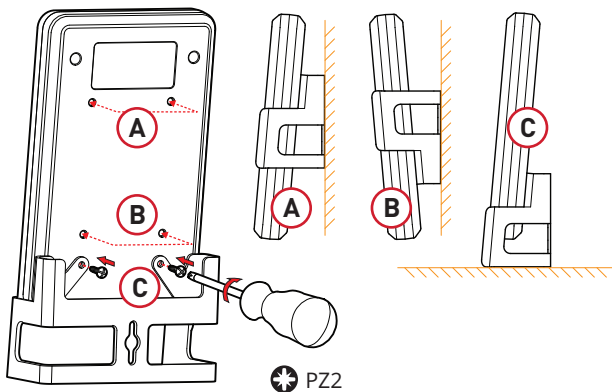

3. Connect power to the device

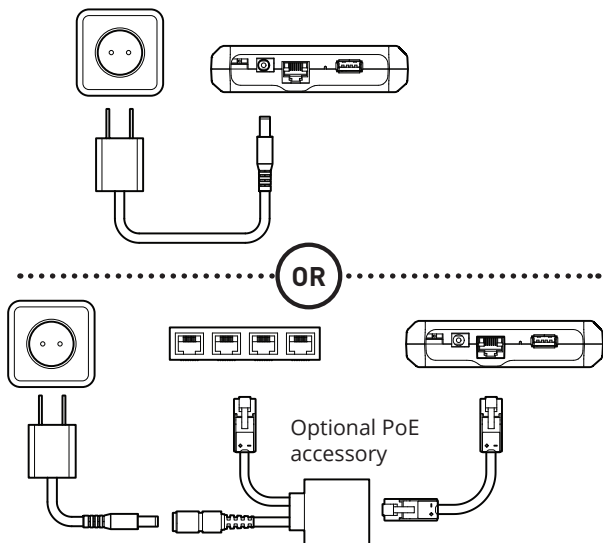

4. Turn the device on

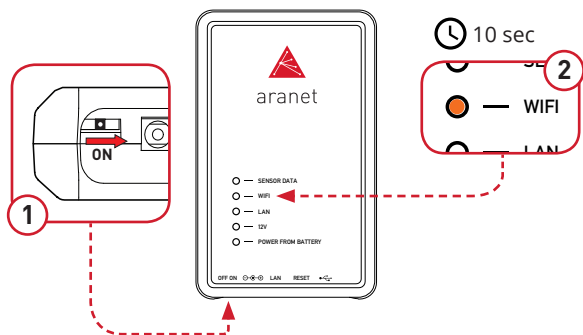

5. Connect to the device



WiFi SSID "Aranet-*****"

1



http://192.168.206.100

2

Login

Username

root

Password

.....



Remember me

LOGIN

**THE DEFAULT
ADMINISTRATOR LOGIN**

Username: **root**

Password: **changeme**

3

6. Configure the device



Change your password, modify and add users in the **Users** setting section.



Set the device time in the **System > Time** setting section.



Scan the availability of the radio channel in the **Sensors > Radio** setting section.



Pair your sensors by pressing the **Add sensor** button in the **Sensors > Sensors** setting section.



Enter the **Notifications** setting section, to configure your sms and/or e-mail notifications.

7. Additional resources

- A** To view Aranet PRO User's Guide visit <https://aranet.com/downloads/>
- B** To view Terms&Conditions visit <https://aranet.com/terms-and-conditions/>
- C** To view Returns&Guarantees visit <https://aranet.com/returns-guarantees/>
- D** To fill RMA form visit <https://aranet.com/rma/>

The information presented in this guide is the property of SAF Tehnika, JSC. No part of this document may be reproduced or transmitted without proper permission from SAF Tehnika, JSC.

The specifications or information contained in this document are subject to change without notice due to continuing introduction of design improvements. If there is any conflict between this document and compliance statements, the latter will supersede this document.

SAF Tehnika, JSC has no liability for typing errors in this document or damages of any kind that result from the use of this document.

To get up to date information about accessories and their availability, please contact sales representative.





Deutsche



- 1 Überprüfen Sie den Lieferumfang
- 2 Montieren Sie das Gerät an der Halterung
- 3 Verbinden Sie das Gerät mit der Spannungsversorgung /
Optionales Zubehör PoE
- 4 Schalten Sie das Gerät ein
- 5 Stellen Sie eine Verbindung mit dem Gerät her
- 6 Konfigurieren Sie das Gerät
- 👤 **Ändern des Passworts** und Ändern oder Hinzufügen von
Benutzer in den **Benutzer**.
- 🕒 Einstellen der Gerätezeit in **System > Zeit**.
- 📶 Prüfen Sie die Kanalverfügbarkeit in **Sensoren > Radio**.
- ⊕ Um Sensoren anzubinden, drücken Sie die **Sensor
hinzufügen** in **Sensoren > Sensoren**.
- ✉️ SMS - und / oder E-Mail-Benachrichtigungen verwalten in den
Benachrichtigung.
- 7 Zusätzliche Ressourcen
- 7A** Um das Aranet PRO Benutzerhandbuch einzusehen, besuchen
Sie
<https://aranet.com/downloads/>
- 7B** Um Terms&Conditions einzusehen, besuchen Sie
<https://aranet.com/terms-and-conditions/>
- 7C** Um Rückgabe-&Garrantiebestimmungen einzusehen,
besuchen Sie
<https://aranet.com/returns-guarantees/>
- 7D** Um unser RMA-Formula auszufüllen, besuchen Sie
<https://aranet.com/rma/>

Español



- 1 Verifique el contenido de la caja
- 2 Adjunte el dispositivo al soporte
- 3 Conecte el dispositivo a la energía / Accesorio opcional PoE
- 4 Encienda el dispositivo
- 5 Conéctese al dispositivo
- 6 Configura el dispositivo
-  **Cambie su contraseña**, modifique y agregue usuarios en la sección Configuración de **Usuarios**.
-  Configure la hora del dispositivo en la sección Configuración del **Sistema > Tiempo**.
-  Escanee la disponibilidad del canal de radio en la sección **Sensores > Configuración de Radio**.
-  Empareje sus sensores presionando el botón **Añadir sensor** en la sección de configuración **Sensores > Sensores**.
-  Ingrese a la sección Configuración de **Notificaciones** para configurar sus sms y / o notificaciones por correo electrónico.
- 7 Recursos adicionales
- 7A** Para ver la Guía del usuario de Aranet PRO, visite <https://aranet.com/downloads/>
- 7B** Para ver los términos y condiciones, visite <https://aranet.com/terms-and-conditions/>
- 7C** Para ver Devoluciones y garantías, visite <https://aranet.com/returns-guarantees/>
- 7D** Para completar el formulario de RMA, visite <https://aranet.com/rma/>





Français



- 1 Vérifiez le contenu de la box
 - 2 Attacher l'appareil à la monture
 - 3 Connectez l'alimentation à l'appareil / Accessoire optionnel de PoE
 - 4 Allumez l'appareil
 - 5 Connectez à l'appareil
 - 6 Configurer l'appareil
- 👤 **Changez votre mot de passe**, modifiez et ajoutez des utilisateurs dans la section **Utilisateurs**.
 - 🕒 Définissez l'heure de l'appareil dans la section **Système > Temps**.
 - 📶 Parcourez la disponibilité du canal radio dans la section **Capteurs > Radio**.
 - ⊕ Associez vos capteurs en appuyant sur le bouton **Ajouter un capteur** dans la section **Capteurs > Capteurs**.
 - ✉ Entrez dans la section **Notifications** pour configurer vos notifications par SMS et / ou e-mail.
- 7 Ressources additionnelles
- 7A** Pour voir le guide de l'utilisateur Aranet PRO, veuillez visiter <https://aranet.com/downloads/>
- 7B** Pour voir les termes et conditions, veuillez visiter <https://aranet.com/terms-and-conditions/>
- 7C** Pour voir les retours et les garanties, veuillez visiter <https://aranet.com/returns-guarantees/>
- 7D** Pour remplir le formulaire RMA, veuillez visiter <https://aranet.com/rma/>

Italiano



- 1 Verificare il contenuto della scatola
- 2 Attaccare il dispositivo al supporto
- 3 Collegare il dispositivo all'alimentazione / Accessorio opzionale PoE
- 4 Accendere il dispositivo
- 5 Connettersi al dispositivo
- 6 Configurare il dispositivo
-  **Cambiare la password**, modificare e aggiungere utenti nella sezione Impostazioni **Utenti**.
-  Impostare l'orario nella sezione **Sistema** > Impostazione **Ora**.
-  Scansionare la disponibilità di canali radio nella sezione **Sensori** > Impostazioni **Radio**.
-  Allineare i sensori premendo il pulsante **Aggiungi Sensore** nella sezione **Sensori** > Impostazioni **Sensori**.
-  Accedere alla sezione Impostazioni **Notifiche** per configurare SMS e/o notifiche via email.
- 7 Risorse aggiuntive
- 7A** Per consultare la Guida d'Utente Aranet PRO visitare <https://aranet.com/downloads/>
- 7B** Per consultare le condizioni di vendita visitare <https://aranet.com/terms-and-conditions/>
- 7C** Per consultare i termini della garanzia visitare <https://aranet.com/returns-guarantees/>
- 7D** Per compilare il modulo RMA visitare <https://aranet.com/rma/>

Latviešu



- 1 Pārbaudiet iepakojuma saturu
 - 2 Pieskrūvējiet stiprinājumu pie ierīces
 - 3 Pievienojiet ierīci pie elektrobarošanas / Papildus PoE aksesuārs
 - 4 Ieslēdziet ierīci
 - 5 Pieslēdzieties ierīcei
 - 6 Iestatiet ierīci
- 👤 Nomainiet paroli, modificējiet un pievienojiet lietotājus**
Lietotāji sadaļā.
- 🕒 Iestatiet laiku un datumu **Sistēma > Laiks** sadaļā.
- 📶 Pārbaudiet radio kanālu pieejamību **Devēji > Radio** sadaļā.
- ⊕ **Pievienojiet devējus**, nospiežot **Pievienot devēju** pogu **Devēji > Devēji** sadaļā.
- ✉️ Apmeklējiet **sadaļu Paziņojumi**, lai mainītu SMS un e-pastu paziņojumu iestatījumus.
- 7 Papildu resursi
- 7A** Lai skatītu pilnu Aranet PRO rokasgrāmatu, apmeklējiet <https://aranet.com/downloads/>
- 7B** Lai skatītu pilnus lietošanas nosacījumus, apmeklējiet <https://aranet.com/terms-and-conditions/>
- 7C** Lai skatītu garantijas un atgriešanas noteikumus, apmeklējiet <https://aranet.com/returns-guarantees/>
- 7D** Lai aizpildītu RMA anketu, apmeklējiet <https://aranet.com/rma/>





Nederlands



- 1 Controleer inhoud van de doos
- 2 Bevestig de standaard aan het apparaat
- 3 Sluit de stroombron aan / PoE optionele accessoire
- 4 Zet het apparaat aan
- 5 Verbind aan het apparaat
- 6 Configureer het apparaat
- 👤 **Verander password, voeg Gebruikers toe in Instellingen.**
- 🕒 Stel tijd in **Systeem > Tijd.**
- 📶 Scan beschikbaarheid radiokanalen in **Sensoren > Radio.**
- ⊕ **Verbind sensor met apparaat door te drukken op Voeg sensor toe in Sensoren > Sensoren instellingen.**
- ✉ Kies **Meldingen** om SMS en/of e-mail notificaties in te stellen.
- 7 Additionele bronnen
- 7A** Om Aranet PRO handleiding te bekijken bezoek <https://aranet.com/downloads/>
- 7B** Om T&C's te bekijken bezoek <https://aranet.com/terms-and-conditions/>
- 7C** Om Retouren en Garanties te bekijken bezoek <https://aranet.com/returns-garantees/>
- 7D** Om RMA formulier in te vullen bezoek <https://aranet.com/rma/>





Norsk



- 1 Sjekk boksens innhold
- 2 Fest enheten til festeanordningen
- 3 Kobl strøm til enheten / Valgfritt tilbehør til PoE
- 4 Slå enheten på
- 5 Tilkobl enheten
- 6 Konfigurer enheten
-  **Endr passordet**, konfigurere og legg til brukere i avdeling **Users**.
-  Angi enhetens tid i avdeling av innstillinger **System > Time**.
-  Utfør skanning av tilgjengelige radiokanaler i avdeling av innstillinger **Sensor > Radio**.
-  Utfør paring av dine sensorer ved å trykke på knappen **Add sensor** i avdeling av innstillinger **Sensors > Sensors**.
-  Gå inn i avdeling av innstillinger **Notifications** for å konfigurere dine sms og/eller e-post varslinger.
- 7 Ytterlige opplysninger
- 7A** For å se på brukerveiledning til "Aranet PRO", vennligst besøk <https://aranet.com/downloads/>
- 7B** For å se på "Betingelser og vilkår", vennligst besøk <https://aranet.com/terms-and-conditions/>
- 7C** For å se på "Retur og garanti", vennligst besøk <https://aranet.com/returns-guarantees/>
- 7D** For å fylle inn RMA-formularen, vennligst besøk <https://aranet.com/rma/>

Portugueses



- 1 Verifique o conteúdo da caixa
- 2 Anexar o dispositivo ao suporte
- 3 Conecte o dispositivo à energia elétrica / Acessório opcional PoE
- 4 Ligue o aparelho
- 5 Conecte-se ao dispositivo
- 6 Configurar o dispositivo
-  **Utilizadores**, modifique e adicione usuários na seção Configuração do **usuário**.
-  Defina a hora do dispositivo na seção **Sistema > Hora**.
-  Analise a disponibilidade do canal de rádio na seção **Sensores > Rádio**.
-  Emparelhe seus sensores pressionando o botão **Adicionar sensor** na seção de configuração **Sensores > Sensores**.
-  Entre na seção de configuração de **Notificações** para configurar suas notificações por SMS e / ou e-mail.
- 7 Recursos adicionais
- 7A** Para ver o Guia do Usuário do Aranet PRO, visite <https://aranet.com/downloads/>
- 7B** Para ver os Termos e Condições, visite <https://aranet.com/terms-and-conditions/>
- 7C** Para visualizar Devoluções e Garantias, visite <https://aranet.com/returns-guarantees/>
- 7D** Para preencher o formulário de RMA, visite <https://aranet.com/rma/>

Русский



- 1 Проверьте содержимое коробки
- 2 Присоедините устройство к креплению
- 3 Подключите питание к устройству / Дополнительный PoE аксессуар
- 4 Включите устройство
- 5 Подключитесь к устройству
- 6 Произведите настройку устройства
- 👤 **Измените свой пароль**, измените и добавьте пользователей в разделе **Пользователи**.
- 🕒 Установите время устройства в **Система** > раздел **Время**.
- 📶 Просканируйте доступность радиоканалов в **Датчики** > раздел **Радио**.
- ⊕ Присоедините свои датчики, нажимая кнопку **Добавить датчик** в **Датчики** > раздел **Датчики**.
- ✉ В разделе **Уведомления** настройте свои уведомления по СМС и/или электронной почте.
- 7 **Дополнительные ресурсы**
- 7A Для просмотра руководства пользователя Aranet PRO посетите <https://aranet.com/downloads/>
- 7B Для просмотра Условий посетите <https://aranet.com/terms-and-conditions/>
- 7C Для просмотра Возвратов и Гарантий посетите <https://aranet.com/returns-guarantees/>
- 7D Для заполнения формы RMA посетите <https://aranet.com/rma/>

Suomalainen



- 1 Tarkista laatikon sisältö
 - 2 Liitä laite kiinnikkeeseen
 - 3 Kytke virta laitteeseen / PoE valinnainen lisävaruste
 - 4 Kytke laite päälle
 - 5 Yhdistä laitteeseen
 - 6 Määritä laitteen asetukset
- 👤 **Vaihda salasanasi**, muuta ja lisää käyttäjät **Users** asetusten osiossa.
 - 🕒 Aseta laitteen aikaa **System > Time** asetusten osiossa.
 - 📶 Tarkista radiokanavien saatavuus **Sensors > Radio** asetusten osiossa.
 - ⊕ Muodosta laitepari painamalla **Add sensor**-painiketta **Sensors > Sensors** asetusten osiossa.
 - ✉ Määritä sms ja/tai sähköposti-ilmoitukset **Notifications** asetusten osiossa.
- 7 Lisäresursseja
 - 7A Nähdäksesi Aranet PRO Käyttöohjee ole hyvä ja käy sivulla <https://aranet.com/downloads/>
 - 7B Nähdäksesi Takuut ja palautukset ole hyvä ja käy sivulla <https://aranet.com/terms-and-conditions/>
 - 7C Om Retour en Garanties te bekijken bezoek <https://aranet.com/returns-guarantees/>
 - 7D Täyttääksesi Palautustodistuslomake (RMA) ole hyvä ja käy sivulla <https://aranet.com/rma/>

Svenska



- 1 Kontrollera innehållet i boxen
- 2 Fäst enheten på fästet
- 3 Anslut ström till enheten / Tillvalstillbehör för PoE
- 4 Slå på enheten
- 5 Anslut enheten
- 6 Konfigurera enheten
- 👤 **Ändra ditt lösenord**, konfigurera och lägg till användare i inställningssektion **Users**.
- 🕒 Ställ in enhetstid i inställningssektion **System > Time**.
- 📶 Utför skanning av tillgängliga radiokanaler i inställningssektion **Sensors > Radio**.
- ⊕ Utför parning av dina sensorer genom att trycka på knappen **Add Sensor** i inställningssektion **Sensors > Sensors**.
- ✉ Gå in i inställningssektion **Notifications** för att konfigurera dina SMS och/eller e-post anmälningar.
- 7 Ytterligare uppgifter
- 7A** För att läsa Användarmanual av "Aranet PRO", besök vänligen <https://aranet.com/downloads/>
- 7B** För att läsa "Regler och villkor", besök vänligen <https://aranet.com/terms-and-conditions/>
- 7C** För att läsa "Returer och garantier", besök vänligen <https://aranet.com/returns-guarantees/>
- 7D** För att fylla i RMA-formuläret, besök vänligen <https://aranet.com/rma/>

Türk



- 1 Kutunun içindekileri kontrol edin
- 2 Cihazı dayanağına monte edin
- 3 Cihaza güç kaynağını bağlayın / PoE opsiyonel aksesuar
- 4 Cihazı açın
- 5 Cihaza bağlayın
- 6 Cihazı konfigüre edin
- 👤 **Parolanızı değiştirin, Kullanıcılar** ayarları bölümünde kullanıcı ekleyin veya modifiye edin.
- 🕒 **Sistem** cihaz zaman ayarını set edin > **Zaman** ayarı bölümü.
- 📶 **Sensörler** radyo kanalının kullanılabilirliğini tara > **Radyo** ayarları bölümü.
- ⊕ **Sensörler Sensör Ekle** düğmesine basarak sensörlerinizi eşleştirin > **Sensörler** ayarları bölümü.
- ✉️ Sms ve / veya e-posta bildirimlerinizi yapılandırmak için **Bildirimler** ayar bölümüne girin.
- 7 Ek kaynaklar
- 7A** Aranet PRO kullanım kılavuzunu görmek için lütfen ziyaret edin <https://aranet.com/downloads/>
- 7B** Şartları ve koşulları görmek için lütfen ziyaret edin <https://aranet.com/terms-and-conditions/>
- 7C** İade ve Garantileri görmek için lütfen ziyaret edin <https://aranet.com/returns-guarantees/>
- 7D** RMA formunu doldurmak için lütfen ziyaret edin <https://aranet.com/rma/>

www.aranet.com